



HS.480

TECHNICAL DATA

INT

hülsta 
SOFA



HS.480

SPECIFICATIONS

Design-oriented modular programme

- ! Organic lines with rounded, curved backrest and side sections
- ! Wrap-around backrest with significant seat depth
- ! Available with very deep modular sofa with 2 backrest heights
- ! Armchair always with high back
- ! Choice of seat comfort grade classic or seat comfort grade classic plus
- ! Scope of range: armchair, sofa bench, modular sofa, XL modular sofa, stool and upholstered bench

Seat comfort grade classic

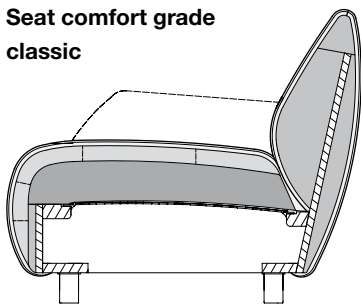

Seat comfort grade classic plus

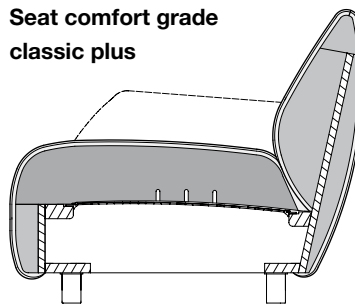

Technical data

- ! Wooden inner frame
- ! Spring system: nosag spring

Seat comfort grade classic:

- ! Seat cushioning made of polyurethane cold foam, "density" = 37 kg/m³, covered with a mat divided into chambers with foam rods/fibre, quilted with nonwoven
- ! Backrest cushioning made of polyurethane cold foam, "density" = 28 kg/m³, quilted with nonwoven

Seat comfort grade classic plus:

- ! Seat cushioning made of polyurethane cold foam, "density" = 37 kg/m³, quilted with nonwoven
- ! Backrest cushioning made of polyurethane cold foam, "density" = 28 kg/m³, quilted with nonwoven

Standard leg:

- ! Plastic leg, black
- ! Metal leg, painted, RAL 9017 Traffic black

The density details stated can vary within a tolerance range of +/-10 %.

Order notes

- ! Seat height optionally 39 cm (plastic leg, black) or 42 cm (metal leg, painted, RAL 9017 Traffic black)
- ! The armchair can also be fitted with soft castors (for hard floor coverings) or with hard castors (for soft floor coverings) on payment of a supplement. Seat height here always 39 cm.
- ! XS armchair: plastic floor protectors, seat height 41 cm. Castors not possible.
- ! Seat comfort grade classic or seat comfort grade classic plus
- ! For the XS-SE, only Classic seating comfort is available for technical reasons.

hülsta 
SOFA



HS.480

RANGE OVERVIEW



The add-on positions are marked with an arrow symbol.

XS Armchair sized: 79 cm

Top view Seitenansicht

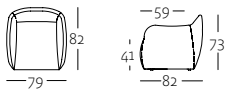

XS-SE 480

Armchair sized: 96 cm

Top view Seitenansicht

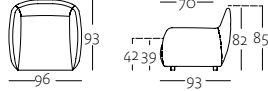

SE 480

Sofa in three size: 194, 214 and 234 cm

Top view

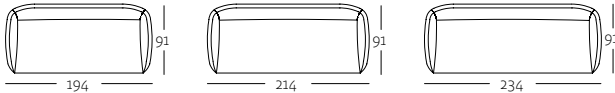

SOB 480/194

SOB 480/214

SOB 480/234

Upholstered

bench element

Footstool

Top view

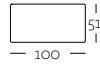

PB 480/100

Top view



HCK 480/63

Sectional sofa in three sizes: 138, 158 and 178 cm

Top view

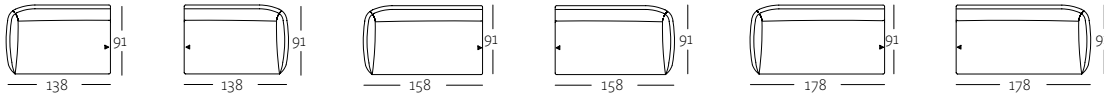

ASO 480/138 le

ASO 480/138 ri

ASO 480/158 le

ASO 480/158 ri

ASO 480/178 le

ASO 480/178 ri

XL sectional sofa sized 120 cm, two back heights: 73/76 (XL-ASO) and 88/91 cm (H-XL-ASO)

Top view

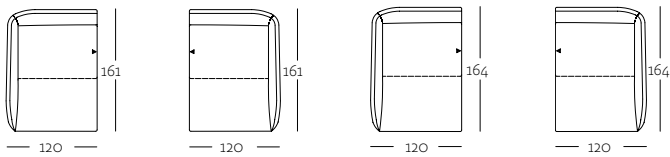

XL-ASO 480/120 le

XL-ASO 480/120 ri

H-XL-ASO 480/120 le

H-XL-ASO 480/120 ri

XL sectional sofa sized 140 cm, two back heights: 73 /76 (XL-ASO) and 88/91 cm (H-XL-ASO)

Top view

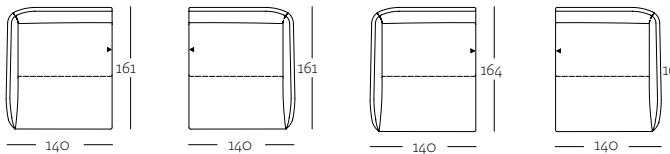

XL-ASO 480/140 le

XL-ASO 480/140 ri

H-XL-ASO 480/140 le

H-XL-ASO 480/140 ri

Side view

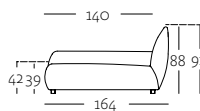

hülsta 
SOFA



HS.480

RANGE OVERVIEW



The add-on positions are marked with an arrow symbol.

Back cushion mat sized: 91 x 63 cm

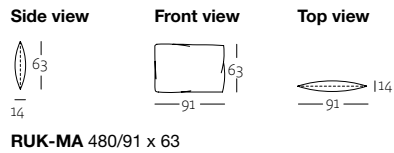

Adjustable back cushion mat sized: 72 x 76 cm

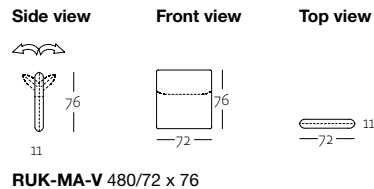

Cushion sized: 60 x 60 cm

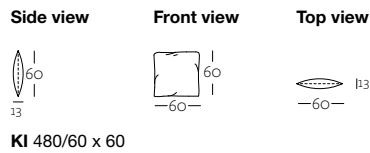

Upholstered cushion sized: 54 x 27 and 40 x 40 cm

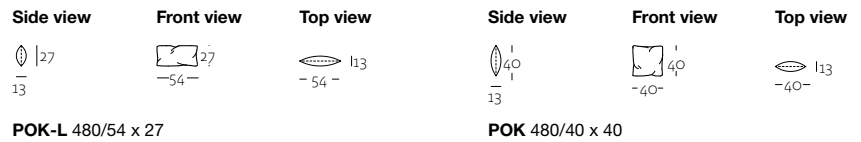

HS.480



LEG OPTION

Standard feet



Plastic leg
Black
height: 5 cm



Metal leg
RAL 9017 Traffic black
height: 8 cm



Castors
Black
height: 5 cm
Notice: Only suitable for SE 480 and SE 490

11/2021

hülsta 
SOFA

hülsta-werke Hüls GmbH & Co. KG

Karl-Hüls-Str. 1

D-48703 Stadtlohn

Tel. +49 (0) 2563 86-0

Fax +49 (0) 2563 86-1417

www.huelsta-sofa.com

Design and concept legally protected, subject to error, subject to alterations in colour and material in line with technological progress.