



HS.450

TECHNICAL DATA

INT

hülsta 
SOFA



HS.450

SPECIFICATIONS

System range for individual sofa configurations

- ! 8 different armrests
- ! 2 levels of seat comfort (classic and lounge)
- ! 2 seat heights
- ! 3 seat depths
- ! 11 base versions
- ! Functions available as an option: footrest and headrest
- ! Scope of range: armchair, sofa with footstool, sectional chair, sectional sofa, corner sectional sofa, corner sectional sofa with fixed footstool, corner modular sofa element, closing chair with fixed footstool, corner sectional sofa, corner unit, upholstered bench element and footstool

Seat comfort "Classic"

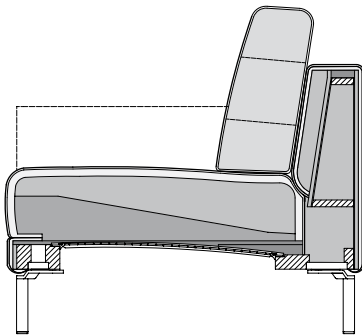

Seat comfort "Lounge"

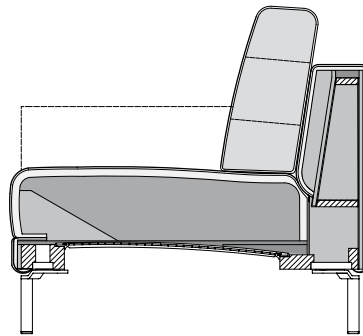

Technical data

- ! Wooden inner frame
- ! Spring system: nosag spring
- ! Seat comfort "Classic" in sandwich construction, "density" 40 and 37 kg/m³ quilted with a fleece
- ! Seat comfort "Lounge" in sandwich construction, "density" 30 and 50 kg/m³ quilted with a fleece
- ! Backrest support made of polyurethane cold foam, "density": 40 kg/m³ quilted with a fleece
- ! Cushion filling made of foam rods and polyester fibres

Standard leg:

- ! Aluminium casting leg, painted RAL 7022 Umbra grey
- ! Steel squared tube leg, painted RAL 7022 Umbra grey
- ! Steel squared tube leg, painted RAL 9017 traffic black, silk matt

Standard side element:

- ! Side element, narrow, low
- ! Side element, wide, low
- ! Side element XS

The density details stated can vary within a tolerance range of +/-10 %.

hülsta 
SOFA



HS.450

SPECIFICATIONS

Order notes

Please indicate on order:

- ! Choice of seat height: 42 or 45 cm
- ! Choice of seat depth: 56, 60 or 64 cm
- ! Choice of side elements: side element narrow low or narrow high, side element wide low or wide high, side element adjustable, side element form (screw), side element XS or side element XL
- ! Different seat depths may be linked at the corner. To do this, EPT or E-ASO elements with different seat depths need to be used. Do not link different seat depths one after the other in a row, otherwise the backrest upholstery will be misaligned.
- ! For technical reasons, the footrest can only be integrated with a seat width of 140 cm or more.
- ! Due to the pivot point, the footrest can be attached only once for each model, and always only to the side section side. With sofa bench models, decide whether the footrest should be assembled on the left or the right-hand side.
- ! Seat depths of the EPT (corner section) are automatically generated.

Surcharges::

- ! The backrest cushions can be selected in another fabric against surcharge
- ! armrest high, narrow or wide, adjustable, form (screw) or XL against surcharge
- ! Seat comfort lounge against surcharge
- ! Footrest against surcharge

Instead of standard leg the following leg option can be chosen against surcharge:

- ! Aluminium casting leg, polished
- ! Steel squared tube leg, polished chrome
- ! Steel round tube angled leg, polished chrome
- ! Wooden leg in natural oak H98
- ! Wooden leg in dark oak H70
- ! Wooden leg in American walnut H81
- ! Steel brace polished chrome (only available for sofa, armchair and footstool)
- ! Steel brace painted, RAL 7022 Umbra grey (only available for sofa, armchair and footstool)



HS.450

SIDE ELEMENT OPTION

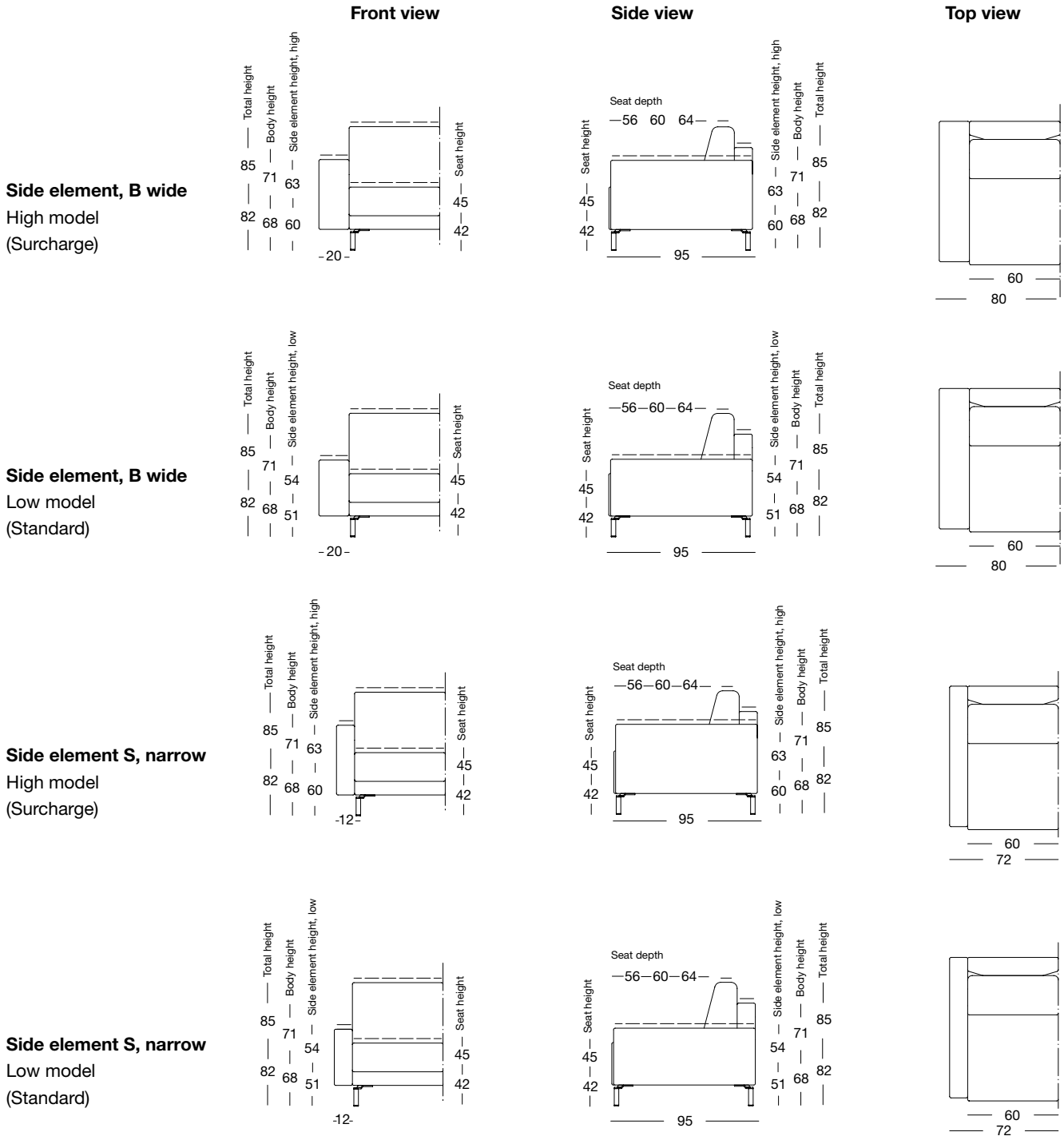



HS.450

SEITENTEILE

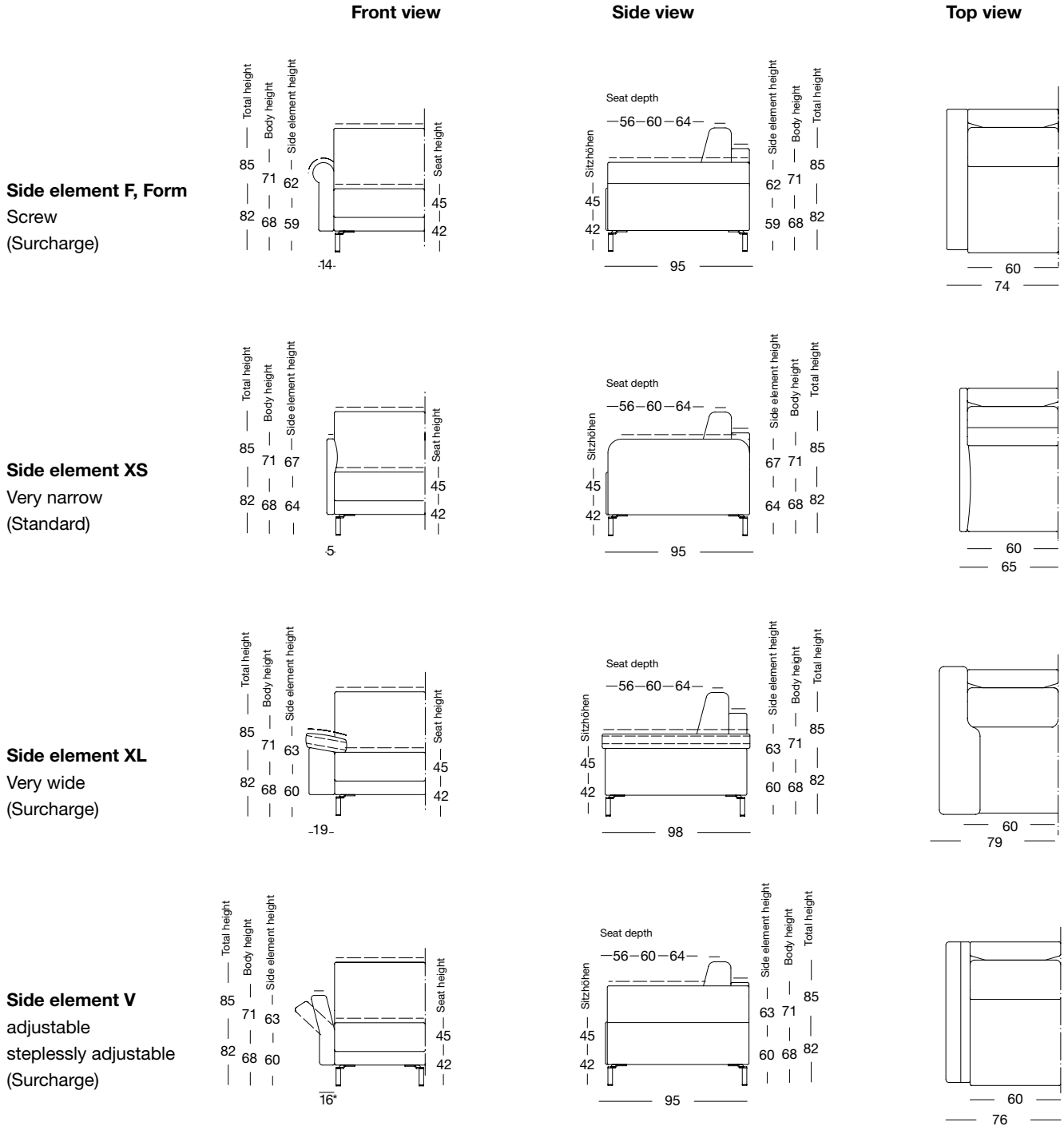



HS.450

Range overview



The add-on positions are marked with an arrow symbol.

Armchair in two seat widths: 60 and 80 cm

Top view

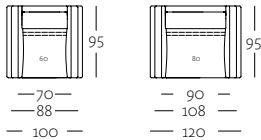

SE 450/SB 60 SE 450/SB 80

Sofa in six seat widths: 100, 120, 140, 160, 180 and 200 cm

Top view

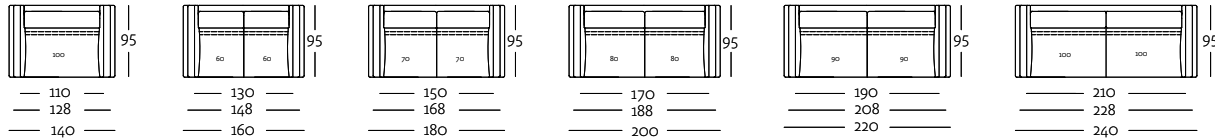

SOB 450/SB 100 SOB 450/SB 120 SOB 450/SB 140 SOB 450/SB 160 SOB 450/SB 180 SOB 450/SB 200

Sofa with footstool and armrest in seat sized: 190 cm

Top view

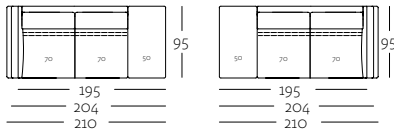

SOB-PSZ-AT 450/SB 190 SOB-PSZ-AT 450/SB 190 re

Sectional sofa in six seat widths:: 100, 120, 140, 160, 180 and 200 cm

Top view

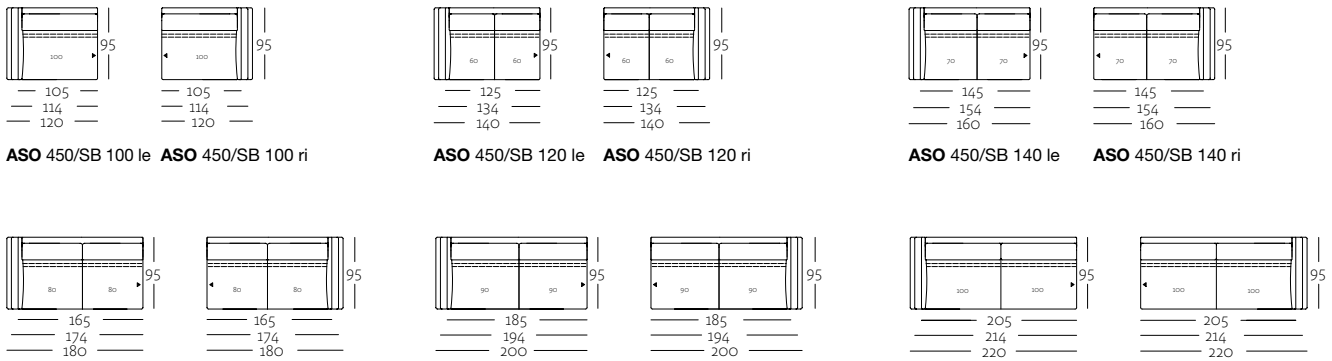

ASO 450/SB 100 le ASO 450/SB 100 ri ASO 450/SB 120 le ASO 450/SB 120 ri ASO 450/SB 140 le ASO 450/SB 140 ri

ASO 450/SB 160 le ASO 450/SB 160 ri ASO 450/SB 180 le ASO 450/SB 180 ri ASO 450/SB 200 le ASO 450/SB 200 ri

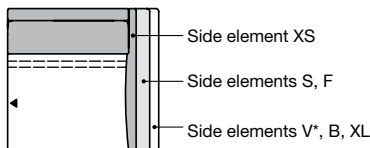

* Side element option V, width approx. 20 cm

hülsta 
SOFA



HS.450

Range overview



The add-on positions are marked with an arrow symbol.

Closing chair with armrest in seat width: 80 cm

Top view

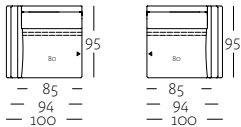

ASS 450/SB 80 le ASS 450/SB 80 ri

Closing chair with fixed footstool in three seat widths: 80, 90 and 100 cm

Top view

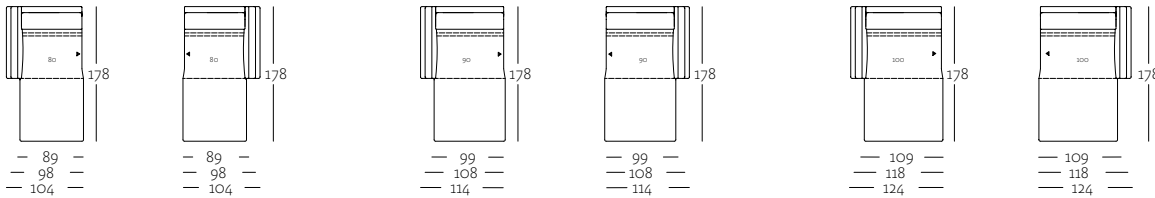

ASS-PSZ 450/SB 80 le ASS-PSZ 450/SB 80 ri

ASS-PSZ 450/SB 90 le ASS-PSZ 450/SB 90 ri

ASS-PSZ 450/SB 100 le ASS-PSZ 450/SB 100 ri

Sectional chair sized: 80 cm

Top view



ASE 450/SB 80

Sectional sofa sized:: 100, 120, 140, 160 and 180 cm

Top view

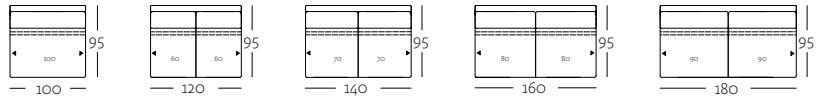

ARB 450/SB 100

ARB 450/SB 120

ARB 450/SB 140

ARB 450/SB 160

ARB 450/SB 180

Sectional sofa with fixed footstool sized: 190 cm

Top view

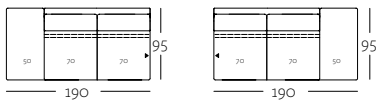

ARB-PSZ 450/SB 190 le

ARB-PSZ 450/SB 190 ri

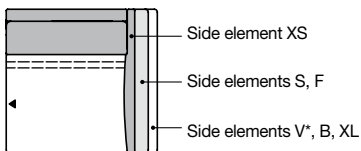

* Side element option V, width approx. 20 cm

hülsta 
SOFA



HS.450

Range overview



The add-on positions are marked with an arrow symbol.

Corner modular sofa element in two seat widths: 180 and 220 cm

Top view

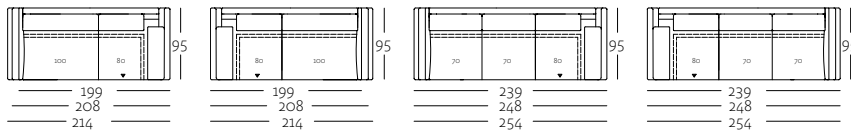

E-ASO 450/SB 180 le

E-ASO 450/SB 180 ri

E-ASO 450/SB 220 le

E-ASO 450/SB 220 ri

Corner unit sized: 80 cm

Top view

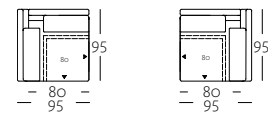

EPT 450/SB 80 ri

EPT 450/SB 80 le

Corner sectional sofa with fixed footstool in two seat widths: 200 and 220 cm

Top view

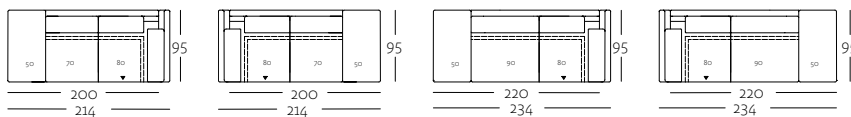

E-ARB-PSZ 450/SB 200 le

E-ARB-PSZ 450/SB 200 ri

E-ARB-PSZ 450/SB 220 le

E-ARB-PSZ 450/SB 220 ri

Footrest

Top view



Footrest 450/le

Footrest 450/ri

Upholstered bench

Top view



PB 450 93

Footstool

Top view



HCK 450 63

Headrest

Side view

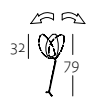

KS 450

Front view

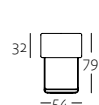

Top view



Back cushion low

Side view



N-RUK 450

Front view

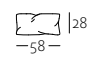

Top view



Back cushion mat sized: 91 x 63 cm

Side view



RUK-MA 430/91 x 63

Front view

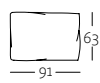

Top view

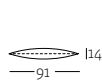

Adjustable back cushion mat sized: 72 x 76 cm

Side view

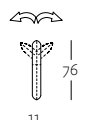

RUK-MA-V 430/72 x 76

Front view

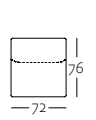

Top view

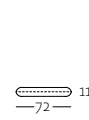

Cushion sized: 60 x 60 cm

Side view



KI 430/60 x 60

Front view

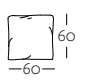

Top view



Upholstered cushion in two sizes: 54 x 27 and 40 x 40 cm

Side view



POK-L 430/54 x 27

Front view



Top view



Side view



POK 430/40 x 40

Front view

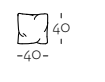

Top view

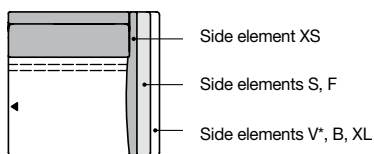

* Side element option V, width approx. 20 cm

hülsta 
SOFA



HS.450

LEG OPTION

Standard feet



Casting leg
Aluminium, painted,
RAL 7022 Umbra grey



Squared tube leg
Steel, painted,
RAL 7022 Umbra grey



Squared tube leg
Steel, painted,
RAL 9017 traffic black, silk matt

Instead of the standard feet, the following feet can be selected for an additional charge:



Casting leg
Aluminium, polished



Squared tube leg
Steel, polished chrome



Round tube angled leg
Steel, polished chrome



Wooden leg
Natural oak, H98



Wooden leg
Dark oak, H70



Wooden leg
American walnut, H81



Steel brace
Steel, polished chrome
(Notice: Only with hs.450
sofa, armchair and
footstool)



Steel brace
Steel painted,
RAL 7022 Umbra grey
(Notice: Only with hs.450
sofa, armchair and footstool)

11/2021

hülsta 
SOFA

hülsta-werke Hüls GmbH & Co. KG

Karl-Hüls-Str. 1

D-48703 Stadtlohn

Tel. +49 (0) 2563 86-0

Fax +49 (0) 2563 86-1417

www.huelsta-sofa.com

Design and concept legally protected, subject to error, subject to alterations in colour and material in line with technological progress.