



# HS.414

TECHNICAL DATA

INT

**hülsta**   
SOFA

# HS.414

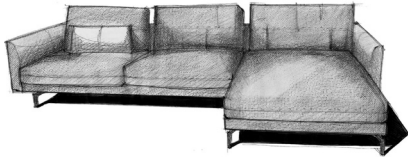

## SPECIFICATIONS

- ! New seat comfort grade "Superior"
- ! The all-round back section makes it possible to have corner combinations
- ! Choice of 9 leg variants
- ! Choice of 2 seat heights (43 and 46 cm) above leg height
- ! Backrest cushion may optionally have a different cover from that of the basic sofa
- ! **Range includes: sofa, sectional sofa, angle sectional sofa, chaise lounge, closing chair with fixed footstool and upholstered bench element**

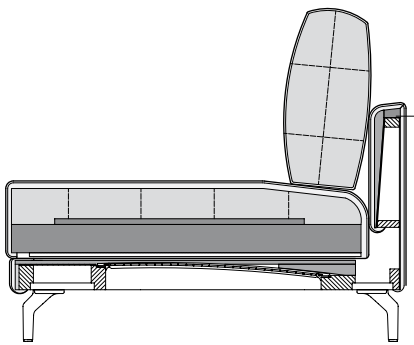

### Technical data

- ! Wooden inner frame
- ! Spring system: nosag spring
- ! Seat comfort grade superior
- ! Seat upholstery made of polyurethane cold foam, „density“ 50 kg/m<sup>3</sup>, covered with a chambered pad filled with foam fibres, cover quilted with non-woven fabric.
- ! Backrest upholstery made of polyurethane „density“ 43 kg/m<sup>3</sup>, cover quilted with non-woven fabric.
- ! Cushion filling of foam rods and polyester fibres

#### Standard foot:

- ! Aluminium casting leg, painted RAL 7022 Umbra grey
- ! Steel squared tube leg, painted RAL 7022 Umbra grey
- ! Steel squared tube leg, painted RAL 9017 traffic black, silk matt

The density details stated can vary within a tolerance range of +/-10 %.

**hülsta**   
SOFA

# HS.414

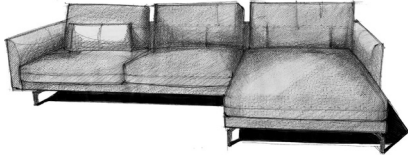

## SPECIFICATIONS

### Order notes

**Please indicate on order:**

- ! Seat height optionally 43 cm or 46 cm.
- ! A different cover material can be chosen for the backrest cushions.
- ! The cover material for the body and the set of cushions must be specified separately.

**Instead of standard leg the following leg option can be chosen against surcharge:**

- ! Aluminium casting leg, polished
- ! Steel squared tube, polished chrome
- ! Steel round tube angled leg, polished chrome (not available with the angle sectional sofa)
- ! Wooden leg in natural oak H98
- ! Wooden leg in dark oak H70
- ! Wooden leg in American walnut H81

- ! This range has especially loose upholstery, so wrinkles will always be visible on the surface of the furniture.

# HS.414

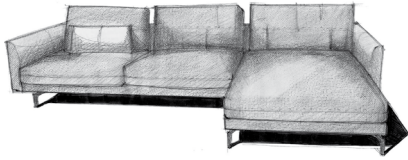

## Range overview



The add-on positions are marked with an arrow symbol.

**Sofa** in four sizes: 180, 200, 220 and 240 cm (Corner arrangement possible)

Top view

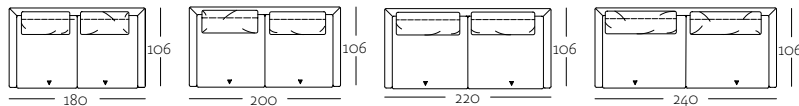

SOB 414/180

SOB 414/200

SOB 414/220

SOB 414/240

Front view

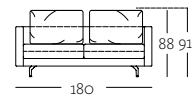

SOB 414/180

**Sectional sofa** in five sizes: 120, 170, 190, 210 and 230 cm (Corner arrangement possible)

Top view

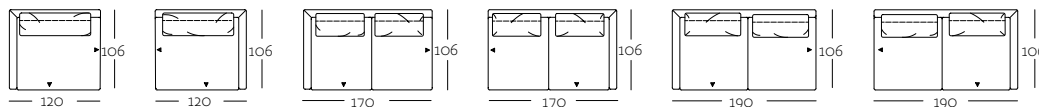

ASO 414/120 le

ASO 414/120 ri

ASO 414/170 le

ASO 414/170 ri

ASO 414/190 le

ASO 414/190 ri

Side view

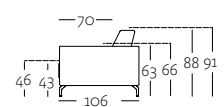

SOB 414

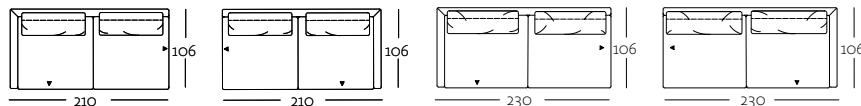

ASO 414/210 le

ASO 414/210 ri

ASO 414/230 le

ASO 414/230 ri

**Sectional sofa** in three sizes: 160, 180 and 200 cm

Top view

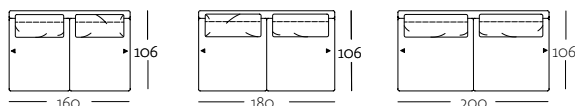

ARB 414/160

ARB 414/180

ARB 414/200

**Chaise lounge** sized: 110 cm

Top view

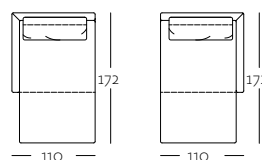

REC 414/110 D le REC 414/110 D ri

**Closing chair with fixed footstool** sized: 110 cm

Top view

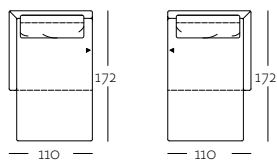

ASS-PSZ 414/110 le ASS-PSZ 414/110 ri

**Extra-deep closing chair with fixed footstool** sized: 120 cm

Top view

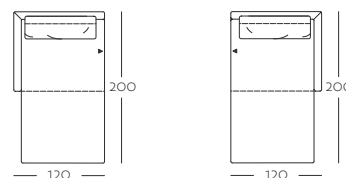

UE-ASS-PSZ 414/120 le UE-ASS-PSZ 414/120 ri

**Angle sectional sofa with fixed footstool** sized: 183 cm

Top view

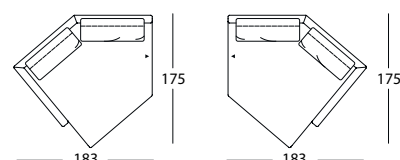

K-W-ASO 414/183 le

K-W-ASO 414/183 ri

**hülsta**   
SOFA

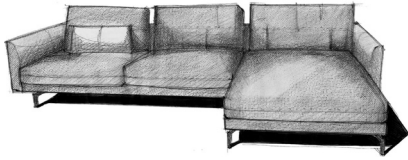

## Range overview



The add-on positions are marked with an arrow symbol.

### Upholstered bench pelement

Top view      Side view      Front view

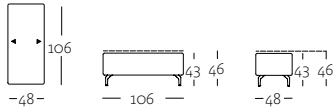

PB 414/48

### Back cushion in four sizes:

64 x 49, 74 x 49, 84 x 49 and 94 x 49 cm

Top view



Front view



Side view



RUK 414/64 x 49    RUK 414/74 x 49    RUK 414/84 x 49    RUK 414/94 x 49

### Additional backrest cushions for corner

combinations dimensions always 64 x 49 cm

Top view



Front view



RUK 414/64 x 49

### Back cushion sized: 78 x 64 cm

Front view    Top view    Side view

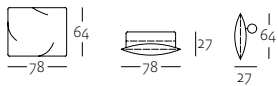

RUK-RO 414/78 x 64

### Back cushion

sized: 63 x 44 cm

Front view    Top view    Side view

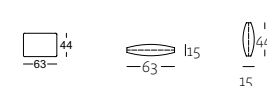

RUK 414/63 x 44

### Cushion in two sizes: 60 x 60 and 63 x 36 cm

Front view    Top view    Side view

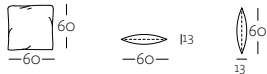

KI 414/60 x 60

Front view    Top view    Side view

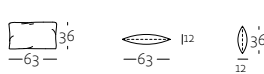

KI 414/63 x 36

### Back cushion mat sized: 91 x 63 cm

Front view    Top view    Side view

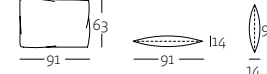

RUK-MA 414/91 x 63

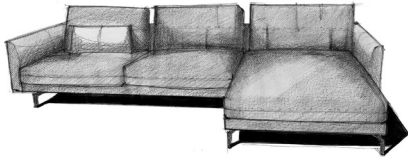

## LEG OPTION

### Standard feet



Casting leg  
Aluminium, painted,  
RAL 7022 Umbra grey



Squared tube leg  
Steel, painted,  
RAL 7022 Umbra grey



Squared tube leg  
Steel, painted,  
RAL 9017 traffic black, silk matt

Instead of the standard feet, the following feet can be selected for an additional charge:



Casting leg  
Aluminium, polished



Squared tube leg  
Steel, polished chrome



Round tube angled leg  
Steel, polished chrome  
(not available with the angle sectional sofa)



Wooden leg  
Natural oak, H98



Wooden leg  
Dark oak, H70



Wooden leg  
American walnut, H81

09/2022



hülsta-werke Hüls GmbH & Co. KG  
Karl-Hüls-Str. 1  
D-48703 Stadtlohn  
Tel. +49 (0) 2563 86-0  
Fax +49 (0) 2563 86-1417  
[www.huelsta-sofa.com](http://www.huelsta-sofa.com)

Design and concept legally protected, subject to error, subject to alterations in colour and material in line with technological progress.